

PelletsUnit ETA PU
7 to 15 kW

ETA^η
... my heating system

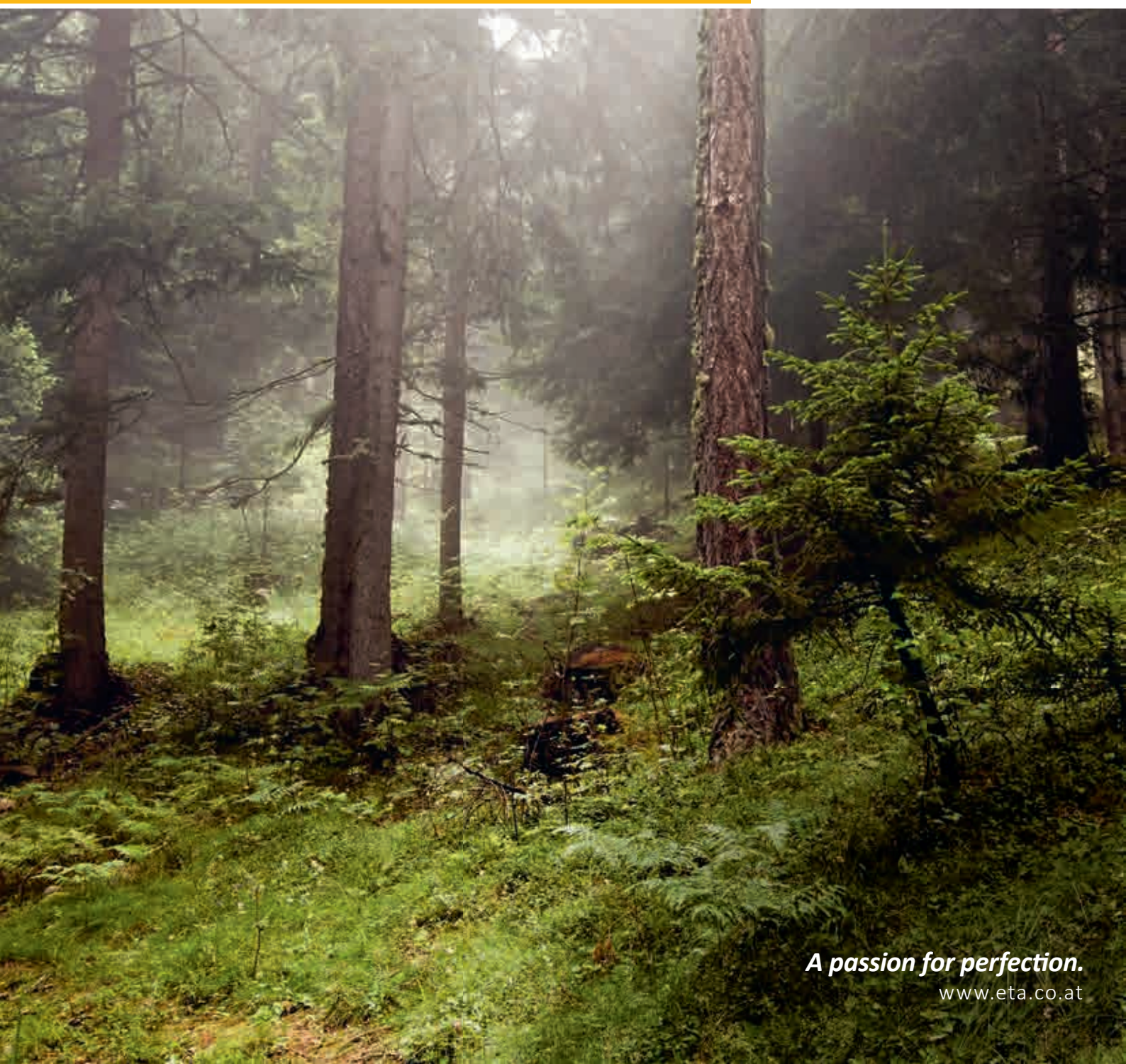

**The pellet boiler for
pleasantly warm single-family homes**



A passion for perfection.
www.eta.co.at

USAGE AREA



Everything already in it

The ETA PelletsUnit is the ideal pellet boiler for both renovated newly built single-family homes and apartment buildings. An entire heating system is packed into a compact boiler. Highly efficient pump, safety devices and more are already integrated. This reduces the space required and installation costs. The PelletsUnit is not just small, but also flexible: even a second heating circuit can be integrated.

Can be set-up anywhere

The ETA PelletsUnit can be operated with external air, i.e. the combustion is supplied with oxygen from outside. This means that the boiler can also be located in heated buildings or in rooms with air conditioning. In fact, the ETA PelletsUnit looks so stylish that you can even set it up where it is visible.

Wood pellets for maximum efficiency

Pellets are balls of energy made from compressed wood by-products. Relying on the pellets means heating fully automatically and with the highest efficiency. Only the ash bin needs to be emptied every now and again. The pellet store room can be up to 20 metres away from the boiler and needs no more space than an oil tank room. The ETA PelletsUnit is also ideal for heating system replacements. So you not only reduce operating costs, but also significantly lower the CO₂-emissions.

Using resources sensibly

In contrast to fuels such as oil and gas, pellets hardly effect the climate. During its growth, the tree absorbs as much CO₂ as it later releases during combustion. In addition, during combustion no more CO₂ is released than when wood waste simply rots.

A win-win situation

Save heating costs, strengthen your local economy and look after the environment in the process: heating with pellets is worth it. A dramatic price rise is also not expected in the future, as wood always regrows. Currently, around 7 million cubic metres of additional wood is grown annually in Austria. This trend is similar across Europe, with forested areas increasing every year.

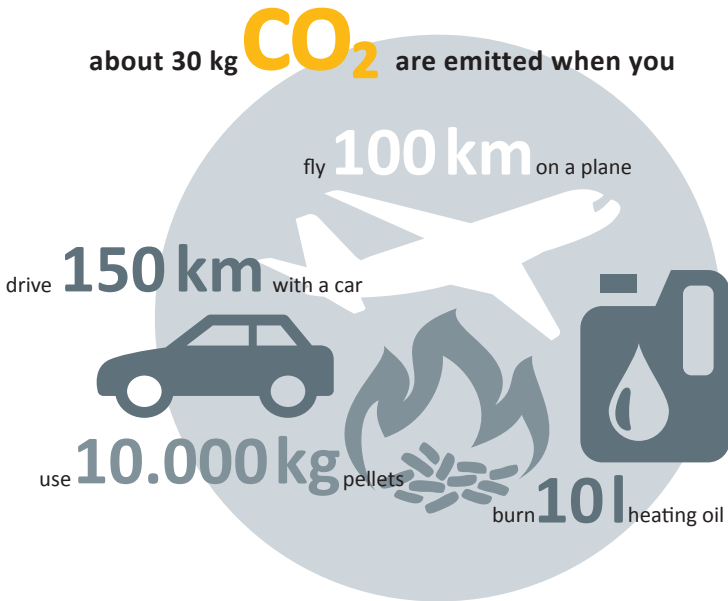
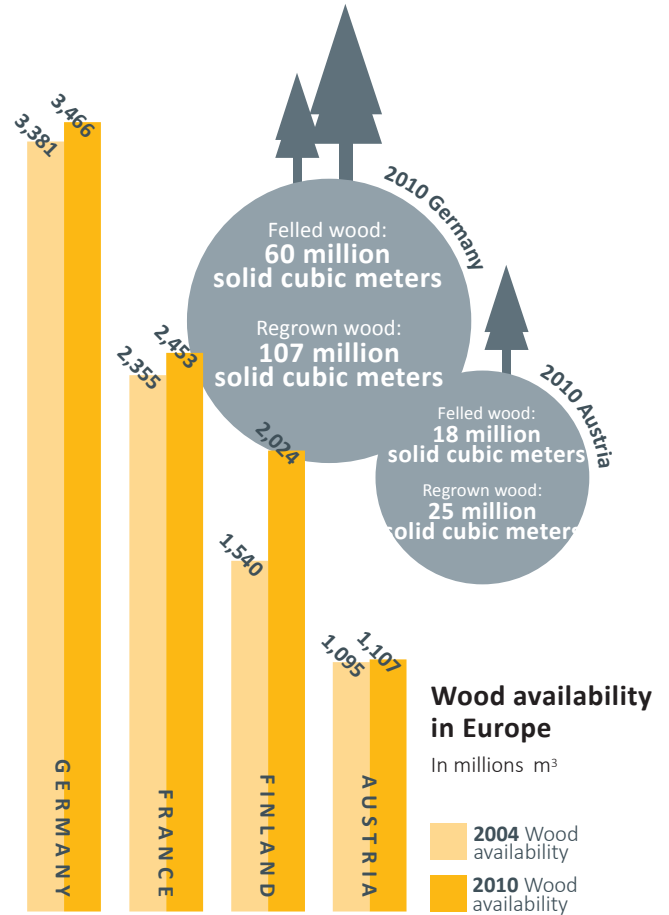

Oil in comparison

Calculation time period: 5 years

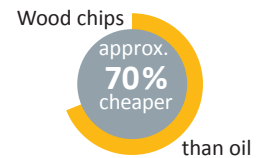

Fuel costs: oil and pellets in comparison

2 tonnes of pellets roughly correspond to 1,000 l of heating oil

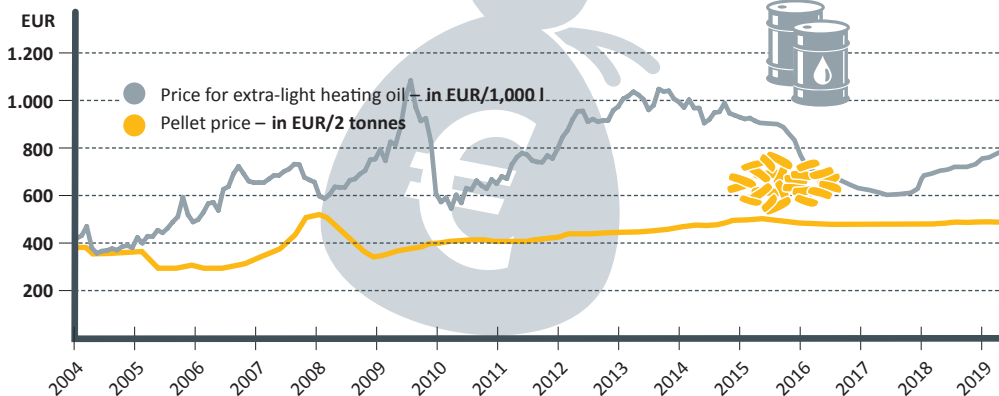

While the prices of fossil fuels such as oil and gas are subject to significant fluctuations in international markets and will certainly rise long-term, the prices of wood and pellets are far more reliable.

Always space for pellets

The pellet store can easily be set up anywhere an oil tank has previously stood. It doesn't even have to be near the boiler, but can be located up to 20 m away. If the pellet store is located beneath the boiler, and if using a suitable conveying system, up to two storeys can be overcome. If there's no space in the house, the store room can also be set up in an adjacent building or an underground tank can be used. The store room just needs to be dry so that the pellets don't swell up. Wooden cladding can help in rather damp rooms.

A clean solution

The pellets, which are created from the compacted waste products of the wood industry, are delivered by tanker and blown into the store room. So the delivery of pellets is an extremely clean and easy process. If the store is sealed, no dust can escape here either.

How do the pellets get to the boiler?

Discharge screw: It stretches the entire length of the store room, can be up to 5 m long and transports the pellets from the store room to the transport hoses, which lead to the boiler. From here, the pellets are conveyed further with a vacuum turbine. After transport the hoses are vacuumed empty. Hence they do not clog up and always work with the highest degree of efficiency. With this standard system, the store room can be completely emptied.



How big does my store room have to be?

The approximate pellet requirement per year in tonnes is calculated by dividing the heating load in kilowatts by 3. To calculate the pellet requirement in cubic metres, divide the heating load by 2. So, for example, for 30 kW heating load you need approx. 10 tonnes or 15 m³ pellets per year.

When moving from another energy source, the pellet requirement can also be determined from the previous consumption. 1 ton of pellets roughly corresponds to:

- 500 l heating oil
- 520 m³ natural gas
- 750 l liquid gas
- 600 kg coke (fuel)
- 1,400 kWh power with geothermal energy pumps (coefficient of performance 3.4)
- 2,700 kWh power with air heat pumps (coefficient of performance 1.8)

Over the inclined smooth floor, the pellets automatically slide to the transport screw. The impact protection mat is suspended opposite the filling nozzles, so that the pellets do not shatter on the wall when they are blown into the store room from the truck. The prerequisite for this construction is that the connections for the transport hoses to the boiler are located on the narrow side of the store room, so that the whole length of the room can be used with the screw.

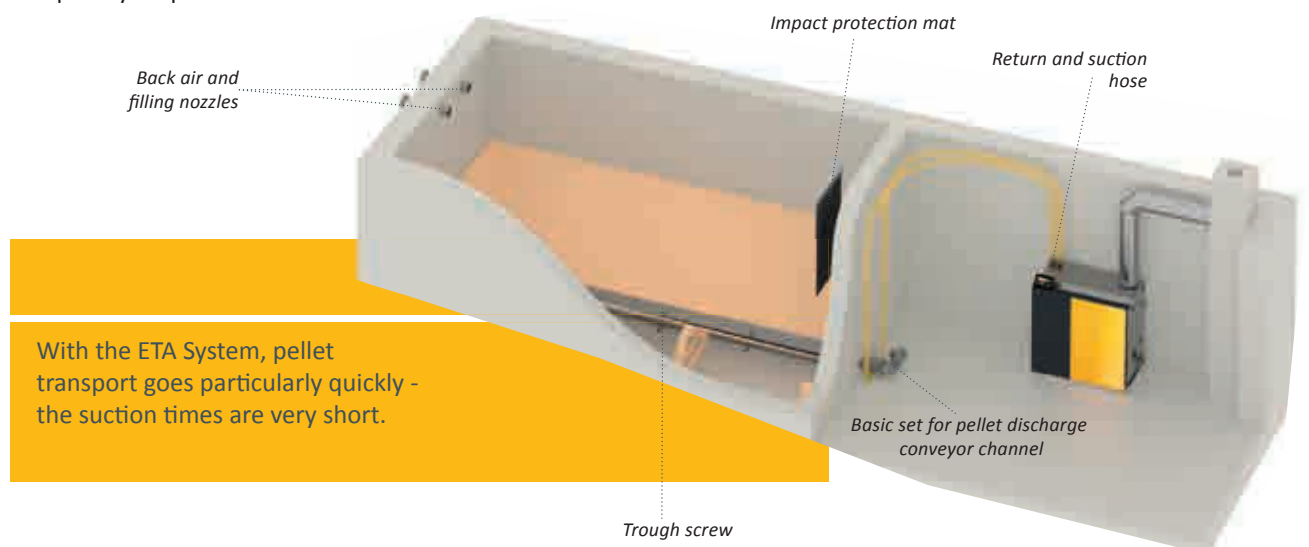

With the ETA System, pellet transport goes particularly quickly - the suction times are very short.

Suction probes:

If the shape of the room is not suitable for a discharge screw, the ETA suction probe system is the ideal choice. Here, the pellets slide over the slanting and smooth wooden floor directly to the four suction probes, which alternately transport pellets away from the store room. Through automatic changeover, the fuel supply is not interrupted if a probe doesn't get any pellets at a certain

point in time. The prerequisite for this system is that the store room is situated opposite the boiler in the same storey or higher, and that the store room is no longer than 4 m. Unlike screws, the suction probes do not fully empty the store room. When the storage room capacity is tight, this can be a disadvantage. The advantage is that this system can be used even in angled store rooms.

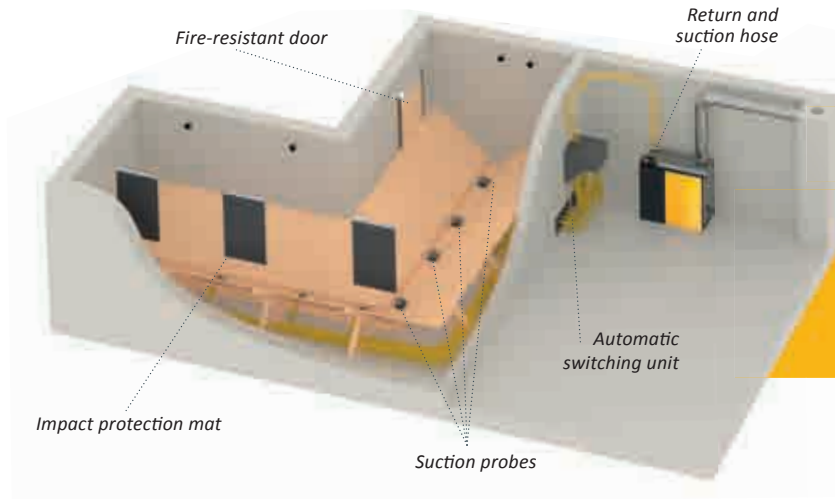

With the suction probes, nearly any room can be used as a pellet store, even if the store room is angular. Eight probes are also possible with larger store rooms.

Mole conveying system:

Due to the structural constraints, conventional ETA pellet conveying systems may have some limitations in terms of usable pellet storage volume. The high quality E3 mole conveying system is a useful application in this situation.



ETA tip: storage in the ETA Box

One particularly practical solution is the ETAbox. It can be set up in the boiler room, in an attic, in a barn or – if covered – even outside. It even keeps the pellets dry in damp rooms. Distances of up to 20 metres of suction hose stretching from the box to the boiler are no problem. Please note that the ETAbox cannot be set up directly on a wall. This is why the space required is a bit larger compared to a brick store with the same capacity.

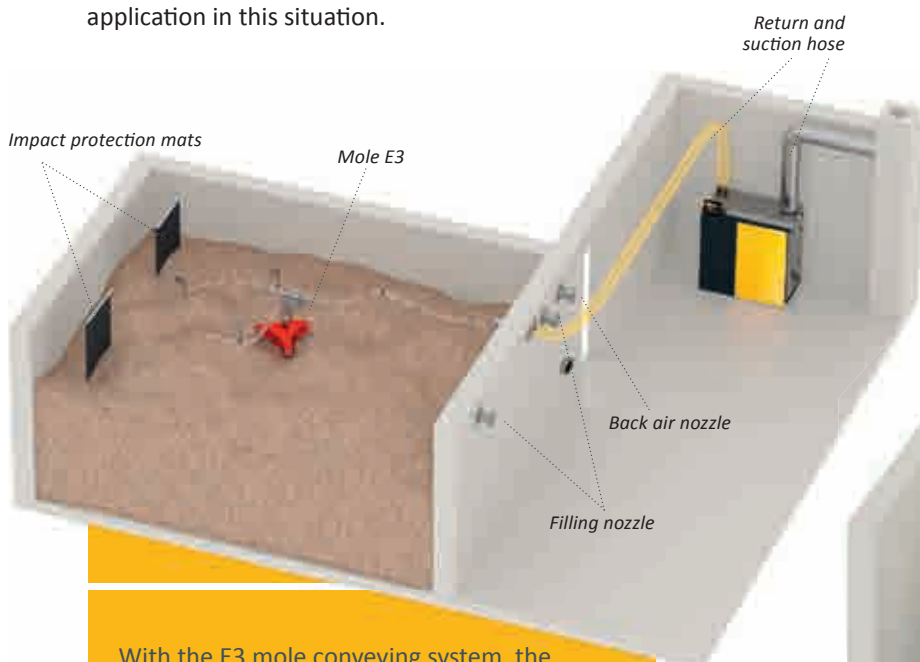

With the E3 mole conveying system, the storage space can be almost completely emptied and the sloping wooden structure is eliminated.



Heat, just the way you need it

The ETA PelletsUnit doesn't just produce heat, the ETA System also distributes it efficiently. Rely on the perfect control centre for your heating and hot water system.

The ETA PelletsUnit is equipped with a control system for the entire heating system. Whether you want to integrate a solar heating system, a conventional hot water preparation system or a buffer storage tank with instantaneous hot water module, whether the energy is transferred with radiators or via floor or wall heating: everything is controlled from a touchscreen on the boiler or via a computer or smartphone. Simple images show you if your solar heating system was operating or how full your buffer is.

With buffer, please

Of course the ETA PelletsUnit can work by itself. However the ETA buffer storage tank is its perfect partner. Above all, when heating in autumn or in spring and for hot water preparation in the summer, often less energy is needed than the boiler

produces. The buffer stores this excess heat and releases it on demand. This saves fuel and protects the boiler, because fewer boiler starts are needed. The ETA stratified buffer is ideal for the integration of a solar heating system. In summer, hot water can be produced at virtually no operating costs. But in winter, the solar collectors seldom produce the 60 °C that are common for hot water preparation. Then the water that is heated by solar energy is fed through the underfloor or wall heating. This usually works with hot water temperatures of just 30 to 40 °C.

The ETA stratified buffer can also be equipped with an instantaneous hot water module, which constantly reheats the tap water with the help of a heat exchanger. This ensures that the risk of germs and bacteria is minimised.

The ETA mixing circuit module for two heating circuits saves a lot of time and money during installation, as no sensor lines, pumps or mixer cables have to be installed.

Remote controlled via the meinETA communication platform

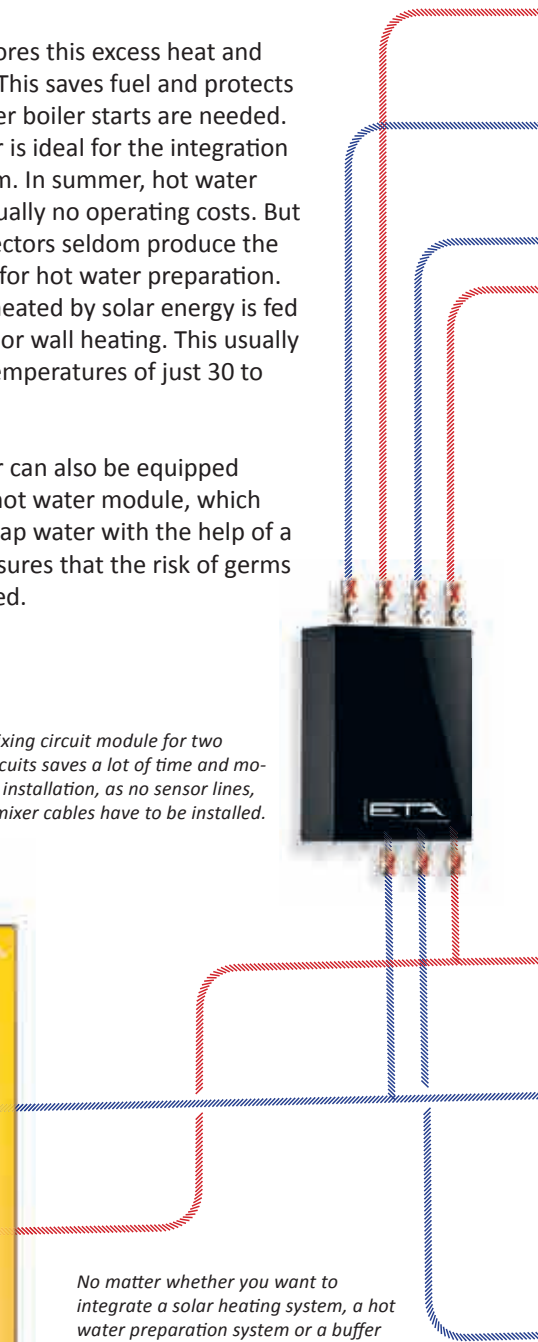

No matter whether you want to integrate a solar heating system, a hot water preparation system or a buffer storage tank with an instantaneous hot water module: the whole system can easily be controlled from a touch screen on the boiler.

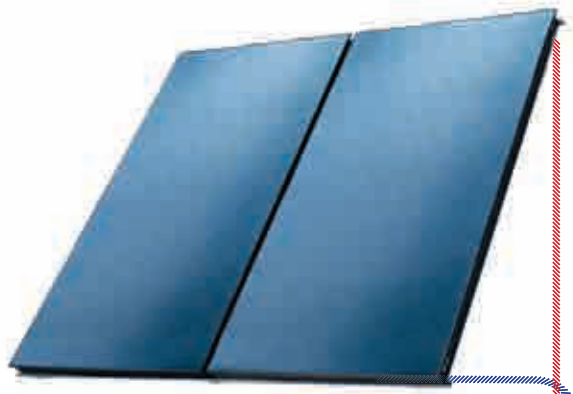

For smaller solar heating systems with large buffer storage tank volumes or for very large solar heating systems, the ETA stratified charging module ensures maximum efficiency.

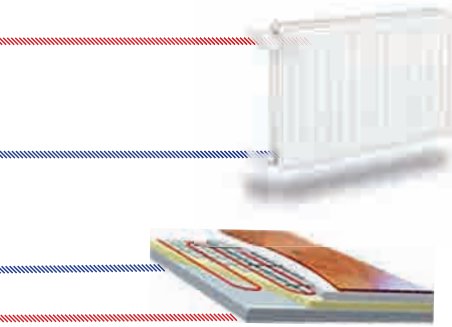

Everything at a glance!
The ETA room sensor displays the room temperature and the outside temperature and enables a simple change of the desired room temperature.

The ETA stratified buffer can also be equipped with an instantaneous hot water module, which constantly reheats the tap water with the help of a heat exchanger. This ensures that the risk of germs and bacteria is minimised.

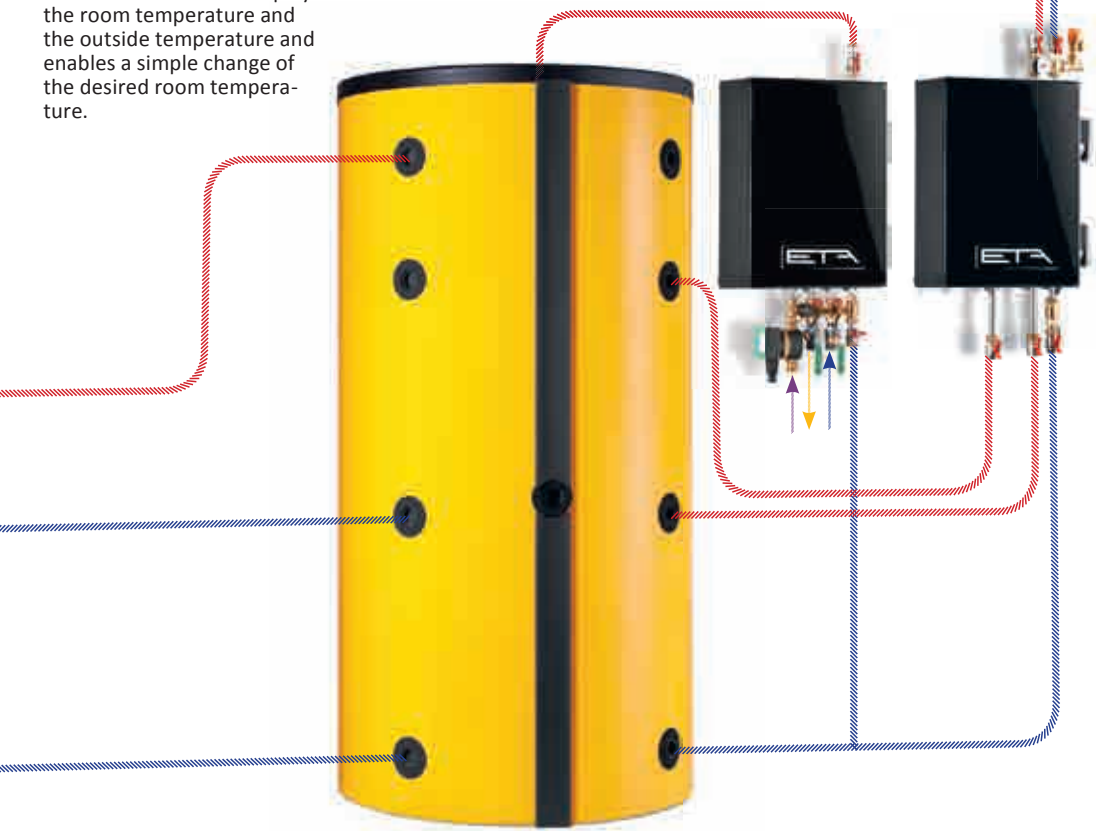

An ETA stratified buffer is the ideal addition to a PelletsUnit. It stores energy that is not required and delivers it on demand.

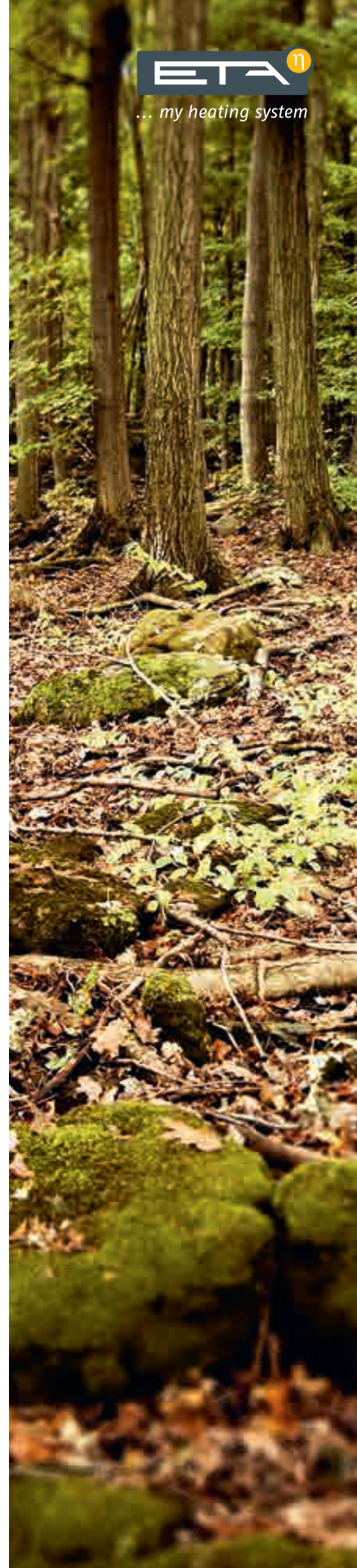

Safe, reliable and easy to use

When selecting a new boiler, you are making a decision that can have an effect on your daily life for many years. You determine how relaxed you feel and how much you have to worry about maintenance and cleaning. This is where quality at a fair price pays!

Automatically clean

The ETA PelletsUnit cleans itself automatically – and not just at certain intervals, but precisely when it's needed. This ensures low emission values and the highest degree of efficiency during the heating season. You never have to open the combustion chamber and get yourself dirty. Not only is the combustion chamber de-ashed effectively, the heat exchanger is also regularly cleared of deposits. As the pellets are burnt very efficiently, less ash is produced. In addition, the ash is compacted in the ash box. Which is why it only needs to be emptied occasionally. And this is easily and quickly done.



Rotary valve

The safe system. The rotary valve completely protects you from burn-back: burning should only take place in the combustion chamber and nowhere else.

A transport screw brings the pellets to the rotary valve – and only as many as the rotary valve can handle. This is why the pellets do not become wedged, crushed or broken. Thanks to this ETA developed system, the sealed edges of the rotary valve do not wear out. The system remains safe throughout the entire life of the boiler.

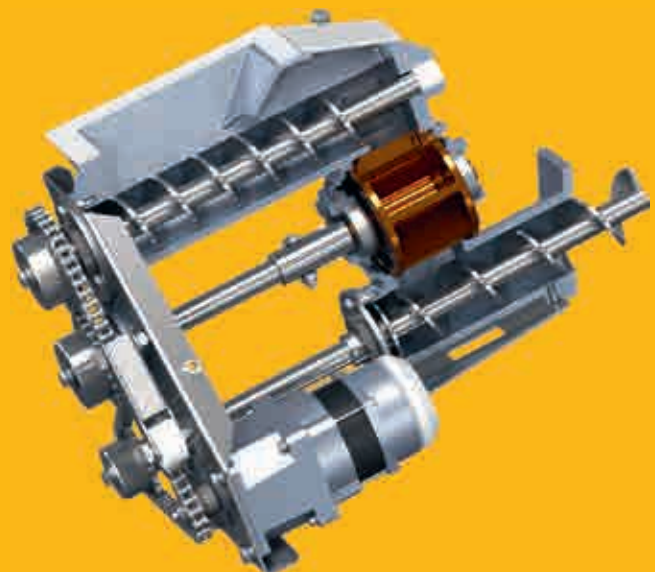

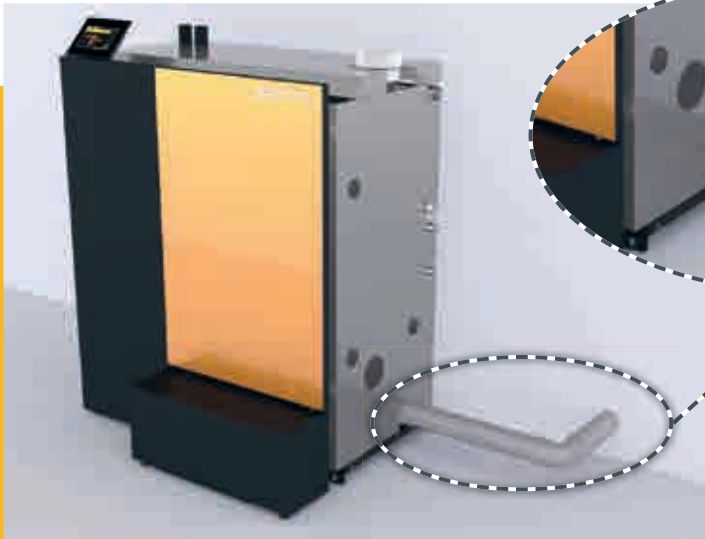

Operation with external air supply. The ETA PelletsUnit can be operated with external air, so the combustion is supplied with oxygen from outside and not from the ambient air in the interior. This means the boiler can also be located within a heated building shell, without having to permanently open a window in the deepest of winter.

Noiseless ceramic igniter

Sparking technology. The energy used for ignition is much lower than other ignition systems. The ignition itself works quicker.



Lambda probe

It's about the mix. With its help, the ratio of fuel and oxygen are mixed perfectly. This means that different pellet qualities achieve the best possible efficiency. In addition, the probe immediately detects if the ignition was successful. This reduces the ignition time and saves power and money.

Control system

Versatile, but not complicated.

Whether combustion control, pellet conveying, buffer management, hot water preparation, weather-compensated heating circuit controlled with a weekly program for two circuits or the connected solar heating system: all of this can be controlled via a touchscreen directly on the boiler or via the internet from any PC, smartphone or tablet. It is a lot, but it is easy to handle as the images on the touchscreen are self-explanatory.







The way to heat

From pellet hopper to combustion chamber to pump: the interplay of high-quality components is needed!

- 1 Vacuum motor:** It transports the pellets from the store room to the boiler's intermediate hopper.
- 2 Pellet bin:** Here 30 kg of pellets are stored temporarily and are immediately available for use. This means pellets have to be transported from the store room to the boiler only once or twice a day for 10 minutes. You can even control when that is.
- 3 Rotary valve as burn-back protection:** It is the completely sealed closing door between store and combustion chamber and therefore safely protects against burn-back.
- 4 Combustion chamber made from stainless steel:** Here, temperatures are produced that are high enough to burn wood cleanly and efficiently. This ensures less ash and low emissions, even under partial load.
- 5 Lambda probe:** With its help, the ratio of fuel and oxygen are mixed perfectly. This means that different pellet qualities always achieve the best possible efficiency.
- 6 Automatic de-ashing in the ash box:** The small amount of ash that still falls despite the optimised combustion processes is firmly compacted in the 12 l ash bin. The ash bin only needs to be emptied every now and again. When it's time, the boiler sends a reminder by email. The ash box is located outside and is therefore easily accessible.
- 7 Expansion tank:** It can take up to 18 litres of heating water and so safely evens out pressure fluctuations within the heating system.



The way through the boiler:

-  Fuel
-  Flue gases
-  Heating water
-  Air

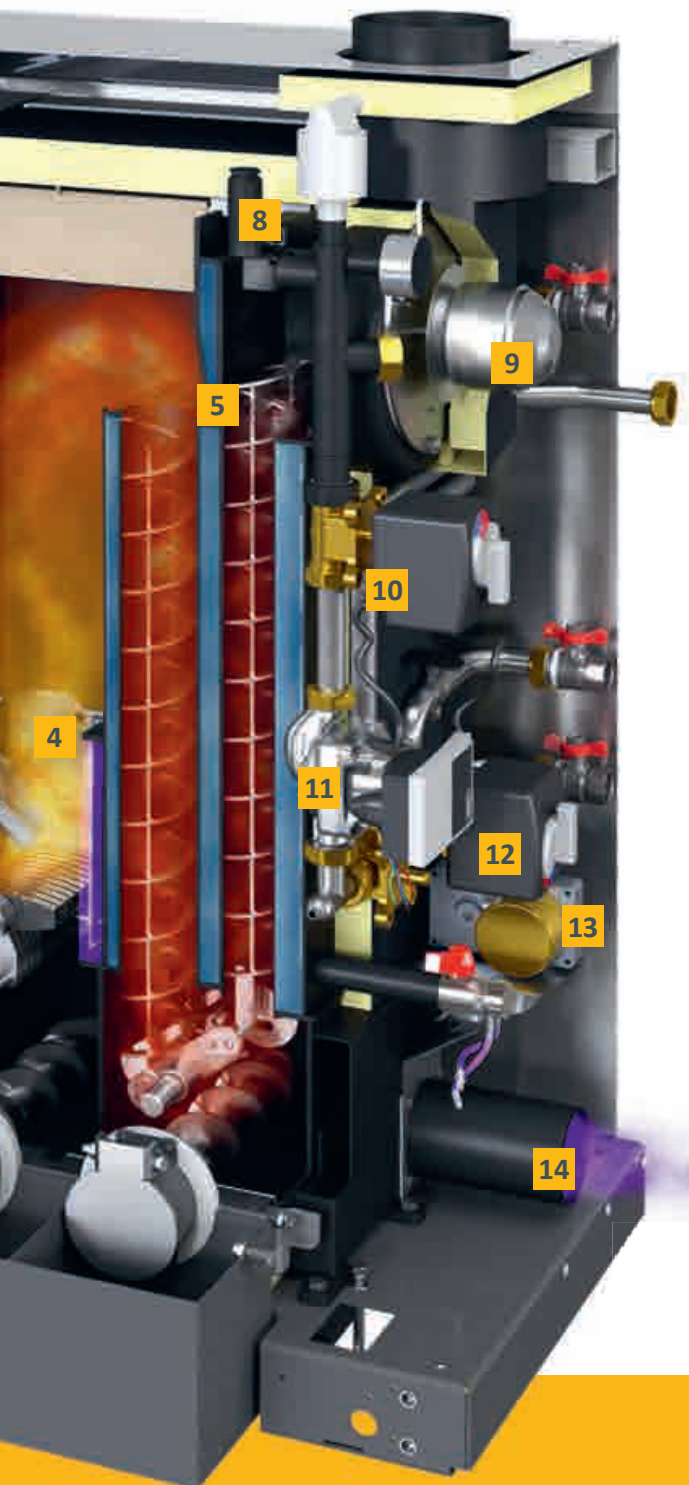

8 Safety devices: A safety valve and an electronic pressure sensor protect the boiler from overpressure. An automatic bleed valve is also integrated, so unwanted air is removed from the water circuit. The boiler does not need a thermal emergency cooling valve, as there is never too much fuel in the boiler that could cause overheating.

9 Draught fan: Quiet as a whisper, this fan ensures underpressure in the boiler. Additionally, it controls the air quantity and thus ensures safety in the boiler room.

10 Mixer: It can be flexibly used depending on system type. With a pluggable actuator, it functions as a flow mixing valve for a heating circuit or as a return riser with mixer for buffer storage tank operation.

11 Pump: It is speed-controlled, highly efficient, energy-saving and ensures the optimum movement of hot water. Depending on the system type, it is either the heating circuit pump for an underfloor heater or radiator heating or it handles buffer charging.

12 Changeover valve: Optionally, only one pump of the heating circuit can be kept in operation or the hot water tank can be charged. The valve automatically switches to the circuit for which the pump should be working.

13 Cleaning drive: It ensures the boiler is clean. The heat exchanger is cleaned automatically with turbulators. The grate is also moved regularly and thus freed of ash. With the help of screws, the ash is automatically transported from the combustion chamber into the ash box.

14 Air connection for external air supply: It collects the air required for combustion from outside. Thus the boiler can be set up safely in any room – for example also with standard room ventilation. Country-specific regulations are to be observed.



Everything already in it

The most important elements for the heat distribution such as the pump, mixer and changeover valve are also integrated into the boiler like the expansion tank, safety valve and bleed valve. That saves space and make installation easier.

Controlled return riser with high-efficiency pump. So as not to damage the heat exchanger, the water returning from the heating circuit must be brought to a certain temperature. The pump is highly efficient and also very economical with 15 to maximum 35 W power.

Draught fan

Underpressure in the boiler. Quiet as a whisper, this speed-controlled fan ensures underpressure in the boiler and determines the air quantity for the combustion. Energy-saving it ensures consistent combustion results – largely independent of the condition of the chimney. No draught limiter is required for flue draughts of up to 15 Pa.



Revolving grate with cleaning comb

Clean burns well. This patented system cleans the combustion chamber of ash regularly – automatically after 15 to 30 kg of pellets are burnt. The air required for the combustion process is distributed evenly between the clean grate segments. Additionally, the grate is constantly kept in slight motion. The gentle movement stokes the firebed and thus ensures even better combustion.

The ash is compacted and ends up in the 12 l capacity ash box. Even at full load operation, it only has to be emptied from time to time. When it is needed, the system sends an email or an SMS message. The information is also displayed on the touch display.

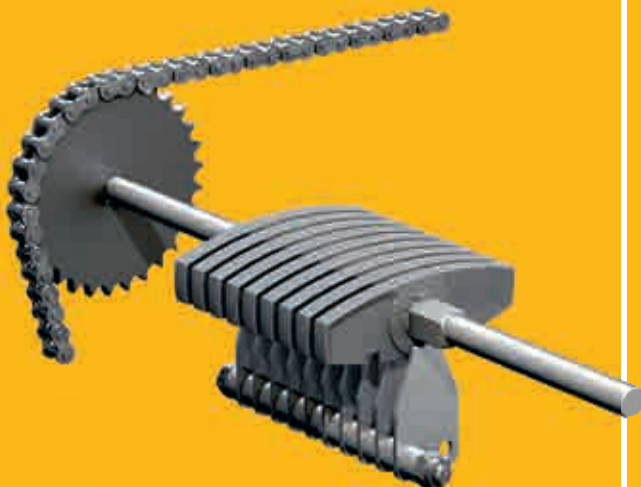

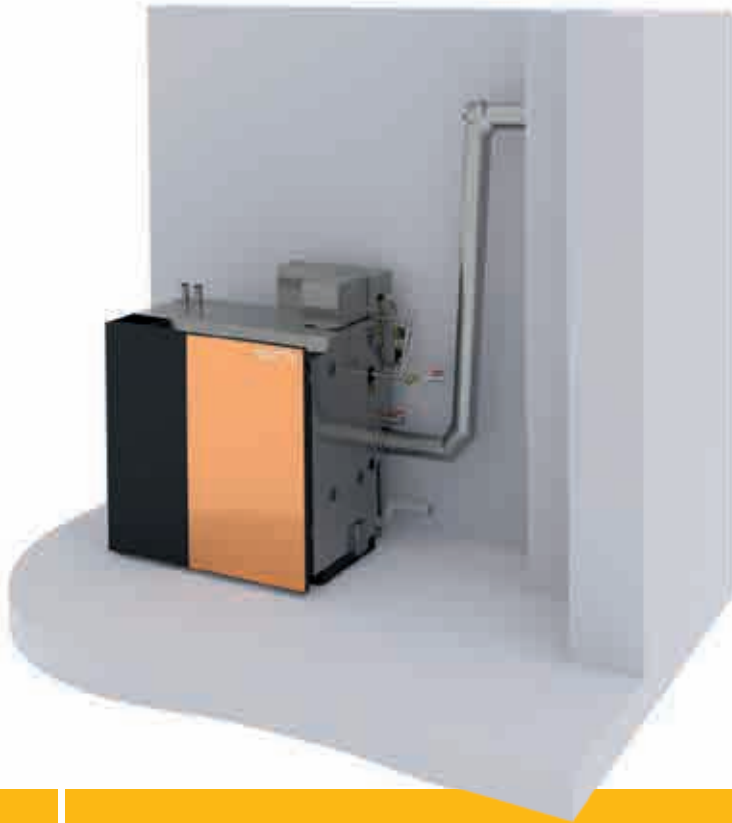

ETA BW condensing heat exchanger

The optional ETA condensing heat exchanger allows fuel savings of up to 10%. The reasons for this are the condensation energy generated and the significantly reduced exhaust gas temperature (with appropriate operation).

Compared to conventional condensing boiler systems, the ETA condensing heat exchanger sets new standards in terms of plant safety. This includes the integrated volume flow sensor and the active control of the water quantity.

Requirements:

- The chimney is moisture-resistant and adapted to the boiler
- Water and sewer connection (for condensate drainage)
- Low return temperatures

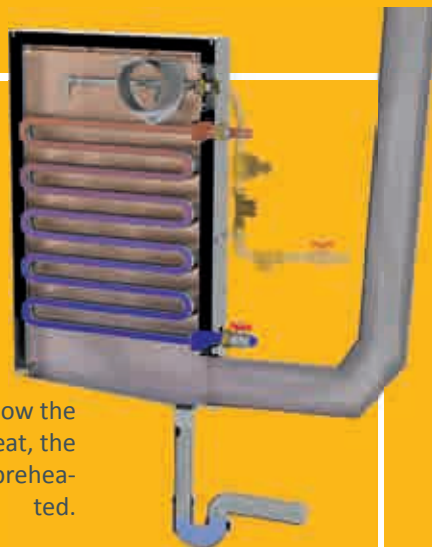

The flue gas is cooled below the dew point. With this heat, the return temperature is preheated.



Automatic cleaning
The water flow during cleaning is determined with an integrated volume flow sensor, thus reducing the water consumption to the bare minimum.

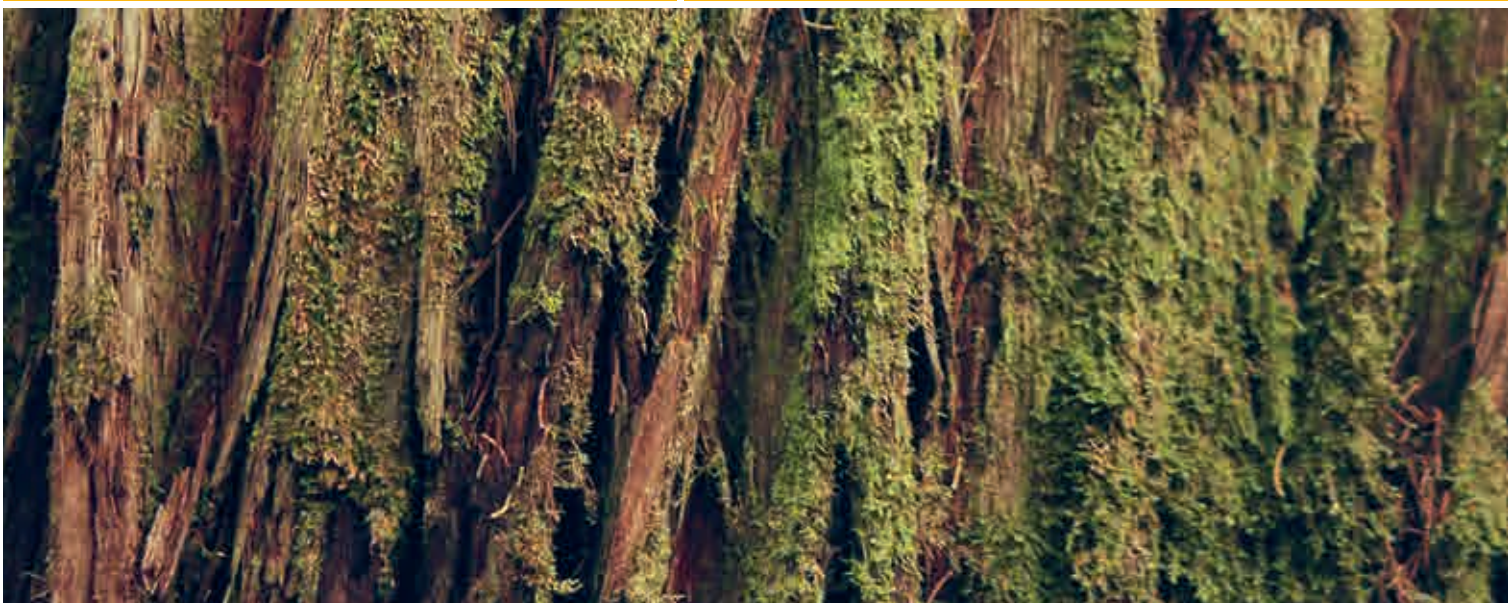



Away mode, night time mode, vacation setting: intuitively, you know immediately which button does what.

Easy to control from anywhere

Good technology is characterised by its user friendliness. You don't have to be a technician to use the many functions of the ETAtouch.



You can control the boiler via smartphone, PC or tablet as well as directly on the touchscreen.

ETAtouch: the touchscreen on the boiler

Confusingly arranged buttons and control systems are a thing of the past, because with the touchscreen of the ETA PelletsUnit you can quickly and easily control every setting. The icons are self-explanatory. Whether you generally want to make it warmer or cooler, change the time for night-time mode or want to switch to eco mode during your vacation - you will tap on the right symbol intuitively and entirely without reading operating manuals!

You not only control your boiler via the touchscreen, but also have an overview of all connected components, such as buffer storage tank, pellet store, solar heating system or hot water preparation. You know straightaway, for example, how many pellets you still have in store or how effective your solar heating system was.

meinETA: the free internet platform

If your boiler is connected to the internet, you can see and change all heating settings on your mobile, tablet or PC. So you always have a handle on your

heating, wherever you are! When you login to www.meinETA.at, you see the touchscreen as if you were standing right in front of the boiler!

The pellet store needs filling, the ash bin must be emptied, it's time for the next heating service... You don't have to remember all these things yourself. meinETA reminds you for free by email.

Quick help

Give your installer or the ETA customer service representative temporary access rights to your meinETA account. So they can prepare for their visit to you. And maybe the technician doesn't even have to visit, because thanks to meinETA they can tell you over the phone what you need to do to make your boiler work again. You can see who can access your boiler via the status display. Only you decide who's in your partner network!



*Come home to a warm house:
the boiler can also be controlled
while you're on the go.*

Technical requirements for meinETA

To be able to use meinETA, you need a broadband connection in your home. The ETA boiler's touch screen is connected to the Internet via a network cable. And anyone who doesn't have a network connection in the basement simply connects via the ETA PowerLine. It effortlessly transfers the data from any power socket to the modem.

For tablet, smartphone and PC

meinETA runs on all current operating systems, such as iOS or Android. Via PC, meinETA can be loaded by any modern internet browser, such as Mozilla Firefox, Safari, Google Chrome or Internet Explorer 9.

Integration into Building Management

The integration into an on-site building management or master control system is completely unproblematic. Values can be queried and changed with RESTful web services and Modbus/TCP.



There for you

ETA devices are characterised by the highest quality. They feature patented systems developed in Austria. The entire assembly takes place in-house in Hausruckviertal, Austria. In the unlikely event of a breakdown, ETA customer service is on the spot quickly. An experienced, competent on-call team is available to you.

Everything on one display: the ETA Standard

A modern heating system is only effective if it is well-controlled. ETAtouch takes care of that.

At no added cost, the ETAtouch control system already includes all functions for two heating circuits, hot water supply via tank or instantaneous hot water module, as well as for the integration of a solar heating system. All ETA heating boilers also come with a LAN connection as standard. If you connect the boiler to the internet, you can easily control all components from a PC, tablet or smartphone.

Boiler and combustion regulation*

Speed-controlling the several components save power. The lambda and ignition time regulation increases efficiency. All components relevant to operation are monitored.

Buffer storage tank management**

Three to nine sensors in the tank control the heat generator in the system and distribute the energy to the different consumers. From using five sensors, cascading regulation, QM-Holz and peak load management are part of the ETA Standard.

Hot water preparation*

Is made possible both via the ETA instantaneous hot water module but also via the hot water tank or combination tank. For all variants, circulation pumps can be controlled with time and/or requirement programs.

Solar heating systems**

Single or double circuit solar heating systems with one or two tanks, zone loading via the ETA stratified charging module and also two collector fields as well as three consumers are controlled.

Two weather-controlled mixing heating circuits**

They run with a weekly program which allows many time windows and automatic and/or manual additional functions. The system can optionally be expanded with room sensors and remote control.



Comprehensible also without the need for an operating manual: The symbols on the touchscreen are self-explanatory. So controlling the heating system becomes child's play.

Additional system functions

Detection of third-party heating devices, such as oil boilers, gas boilers, heat pumps and wood burning stoves, thermostat or differential temperature thermostat, external demand from external devices such as heating fans, control of transmission lines, with or without mixers, and also of heat transfer stations, single room control systems, for example.

Wall-mounted control box for more complex systems

All control systems can be extended with wall-mounted control boxes, with or without touchscreen.

* Control system and sensor included in standard delivery scope

** Control system depends on configuration, sensors are available as accessory

From Hausruckviertel to the world

ETA specialises in the manufacture of biomass heating, i.e. log, pellet and wood chip boilers. The most modern technologies combined with naturally growing resources.

ETA is efficient

Technicians designate the efficiency of a heating system with the Greek letter η , pronounced „eta“. ETA boilers stand for more heat with less fuel consumption, environmental soundness and sustainability.

Wood: old but excellent

Wood is our oldest fuel - and our most modern: There is a lot of history - from open fires in front of caves to modern biomass boilers. In the middle of the 20th century, the number of wood heating systems briefly fell. Oil heating became the new, hyped option. A brief interlude in comparison to the consistency of wood. Today, we know that heating with fossil fuel has no future. It contributes to global warming and harms the environment. Supply security is also not guaranteed in the long term, as fossil fuels are being depleted, aren't renewable and often come from unstable regions. While wood by contrast is a cheaper, locally grown, renewable raw material that does not pollute the climate when burnt. No wonder wood heating is booming!

Comfort with many components

Since December 1998, the Upper Austrian company ETA has been designing and building a new generation of wood-fired boilers. They are full of patented technologies and the most modern control technology – making them easy to use. Convenience and efficiency make ETA products so popular around the world. With a production capacity of up to 20,000 boilers per year and a global export proportion of around 80%, ETA is one of the leading biomass boiler producers.

You get more than just a boiler

Anyone who decides on a wood or pellet boiler from ETA is choosing sustainability. This is not just in terms of fuel, but encompasses responsibility across the board, with sustainable workplaces in the region. More than 200 employees in Hofkirchen an der Trattnach have the best working conditions – including an in-house restaurant, bright assembly and storage halls, a fitness room and a sauna. There is even a free electric charging station for electric cars, which is supplied by the in-house photovoltaic system. This also covers all the power needed of a production hall and thus saves around 230 tonnes of CO₂ per year.



Ideal for new builds and renovations

The ETA PelletsUnit fits into any house. It can be set up in the cellar or in the attic. The pellet store can be up to two storeys or 20 m away.

- 1** Pellet suction hose DN50
- 2** Pellet back air DN50
- 3** Return for heating circuit 1 and hot water tank, R3/4" coupling
- 4** Optional heating circuit 2 return, R3/4" coupling
- 5** Optional heating circuit 2 flow, R3/4" coupling
- 6** Flow for hot water tank, R3/4" coupling
- 7** Heating circuit 1 flow, R3/4" coupling
- 8** Discharge fitted with 1/2" filling and drainage valve
- 9** Outlet for the safety valve, coupling R3/4"
- 10** Air connection for external air supply, DN80

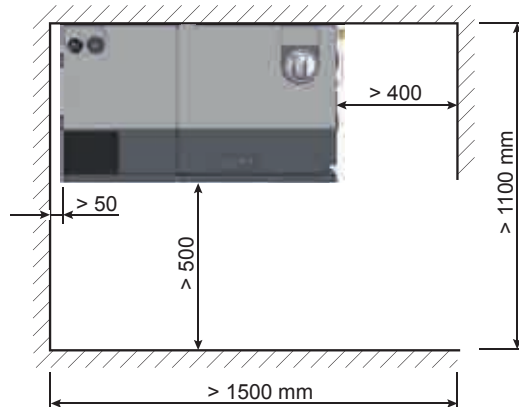
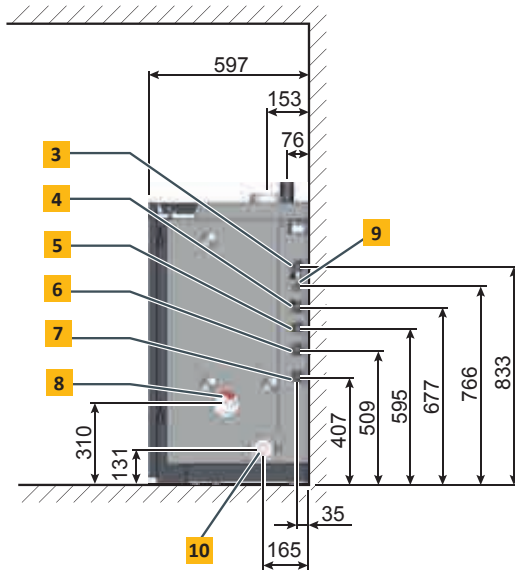
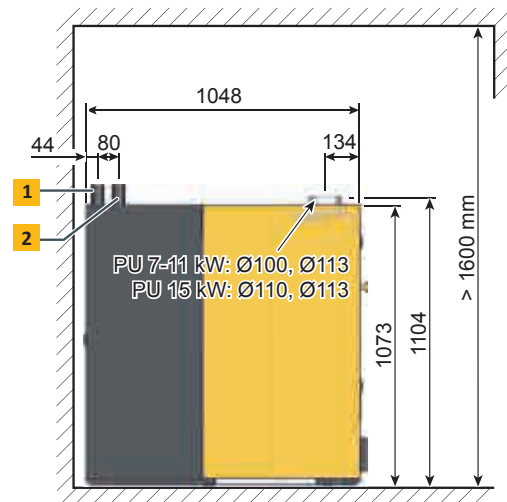



| PelletsUnit | | 7 | 11 | 15 |
|--|----------------------------|--|-------------|-------------|
| Rated capacity | kW | 2.3 - 7.7 | 2.3 - 11.2 | 4.4 - 14.9 |
| Energy efficiency class** | | A+ | A+ | A+ |
| Efficiency at partial / full load* (installation outside living area) | % | 89.3 / 93.4 | 89.3 / 92.5 | 91.5 / 94.2 |
| Transport dimensions, W x D x H | mm | 1,072 x 600 x 1,150 | | |
| Weight | kg | 267 | | |
| Water content | Litres | 27 | | |
| Residual pump head at $\Delta T=7^\circ\text{C}$ Maximum 100 m (80 m better) underfloor heating pipe length per distributor outlet, for heating body speed-controlled depending on the flow temperature | mWS / m ³ /h | 3.8 / 0.9 | 3.5 / 1.3 | 2.4 / 1.8 |
| Maximum distance to pellet store | m | 20 | | |
| Ash box volume | Litres | 12 | | |
| Flue draught required at partial / full load | Pa | >1/>3 above 15 Pa a draught limiter is required | | |
| Electrical power consumption at partial / full load* | W | 46 / 61 | 46 / 63 | 66 / 95 |
| Maximum permissible operating pressure | bar | 3 | | |
| Temperature adjustment range | °C | 30 – 85 | | |
| Maximum permissible operating temperature | °C | 95 | | |
| Boiler class | | 5 acc. to EN303-5:2012 | | |
| Suitable fuels | | Pellets, ENplus A1, ISO 17225-2-A1 | | |
| Electrical connection | | 1x 230 V / 50 Hz / 13 A | | |

*Data from test reports by BLT Wieselburg

**Energy labelling for packages (solid fuel boiler + temperature control)

Technical changes and mistakes reserved!



entspricht
EU-Normen



BLT Wieselburg
Österreich



TÜV
Süddeutschland



Qualitätssiegel
Holzenergie
Schweiz

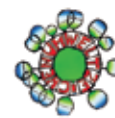

Österreichisches
Umweltzeichen



ETA PU PelletsUnit 7 to 15 kW



ETA PC PelletsCompact 20 to 105 kW



ETA ePE-K Pellet Boiler 100 to 240 kW



ETA SH Wood Gasification Boiler
20 to 60 kW



ETA SH-P Wood Gasification Boiler 20 to 60 kW
with ETA TWIN Pellet Burner 20 to 50 kW



ETA stratified buffer SP 500 to 5,000 lt
and SPS 600 to 2,200 lt



ETA eHACK Wood Chip Boiler
20 to 240 kW



ETA HACK VR Wood Chip Boiler
with moving grate 250-500 kW



ETA Hydraulic modules

Your heating specialist will be happy to advise you:



... my heating system

ETA Heiztechnik GmbH
Gewerbepark 1

A-4716 Hofkirchen an der Trattnach

Tel.: +43 (0)7734 2288-0

Fax: +43 (0)7734 2288-22

info@eta.co.at

www.eta.co.at

Technical changes and mistakes reserved

In order to provide you the benefits of our continuous development, we reserve the right to change specifications without prior notice. Printing and typesetting errors or changes of any kind made in the interim are not cause for claims. Individual configurations depicted or described here are only available as options. In the event of discrepancies between individual documents regarding the scope of delivery, the information provided in our current price list shall prevail. Images and symbols may contain options that are available for an additional cost.

Photo source: ETA Heiztechnik GmbH, Lothar Prokop Photographie, istockphoto, Thinkstockphotos, Photocase, Shutterstock.

94001-EN, Prospekt PelletsUnit ETA PU EN, 2020-03

